

INSTALLATION GUIDE

AeraMax® PRO Air Quality Control System: AM III

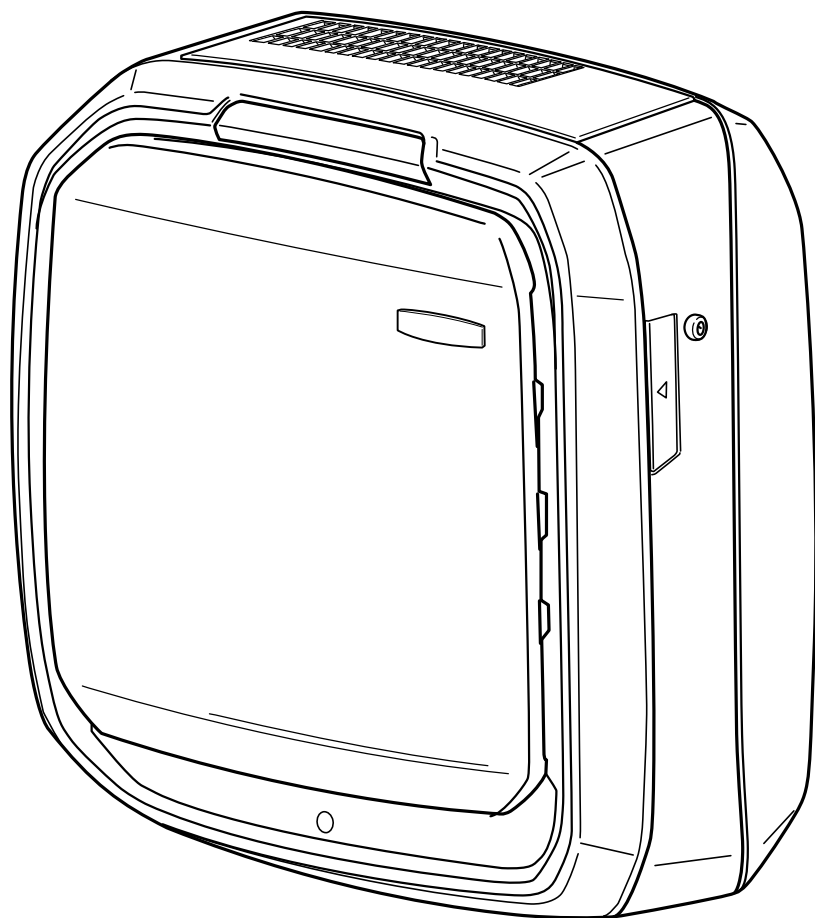

Please read instructions carefully before installing

Veuillez lire les instructions attentivement avant d'installer le produit

Lea cuidadosamente las instrucciones antes de la instalación

Bitte lesen Sie diese Anweisungen vor der Installation sorgfältig durch

Prima dell'installazione, leggere attentamente le istruzioni

Lees de instructies zorgvuldig door voordat u het product installeert

Läs instruktionerna noggrant innan installation

Læs venligst vejledningen omhyggeligt inden installation

Lue ohjeet huolellisesti ennen asennusta

Vennligst les disse instruksjonene nøye før du installerer

Przed przystąpieniem do instalacji należy uważnie przeczytać instrukcję

Перед монтажом внимательно прочитайте инструкции

Διαβάστε προσεκτικά τις οδηγίες πριν από την εγκατάσταση

Kurulum öncesinde lütfen bu talimatları dikkatlice okuyun.

Před zahájením instalace si pozorně přečtěte tyto pokyny

Pred inštaláciou si pozorne prečítajte pokyny

Beszerelés előtt figyelmesen olvassa el az utasításokat

Por favor leia as instruções cuidadosamente antes da instalação

KEY

- 1. Access panel
- 2. Filters
- 3. Filter frame
- 4. Main Assembly
- 5. Power Switch
- 6. Access panel latch
- 7. Access panel lock
- 8. Rear housing assembly
- 9. Control panel
- 10. Filter frame window

Fig 1

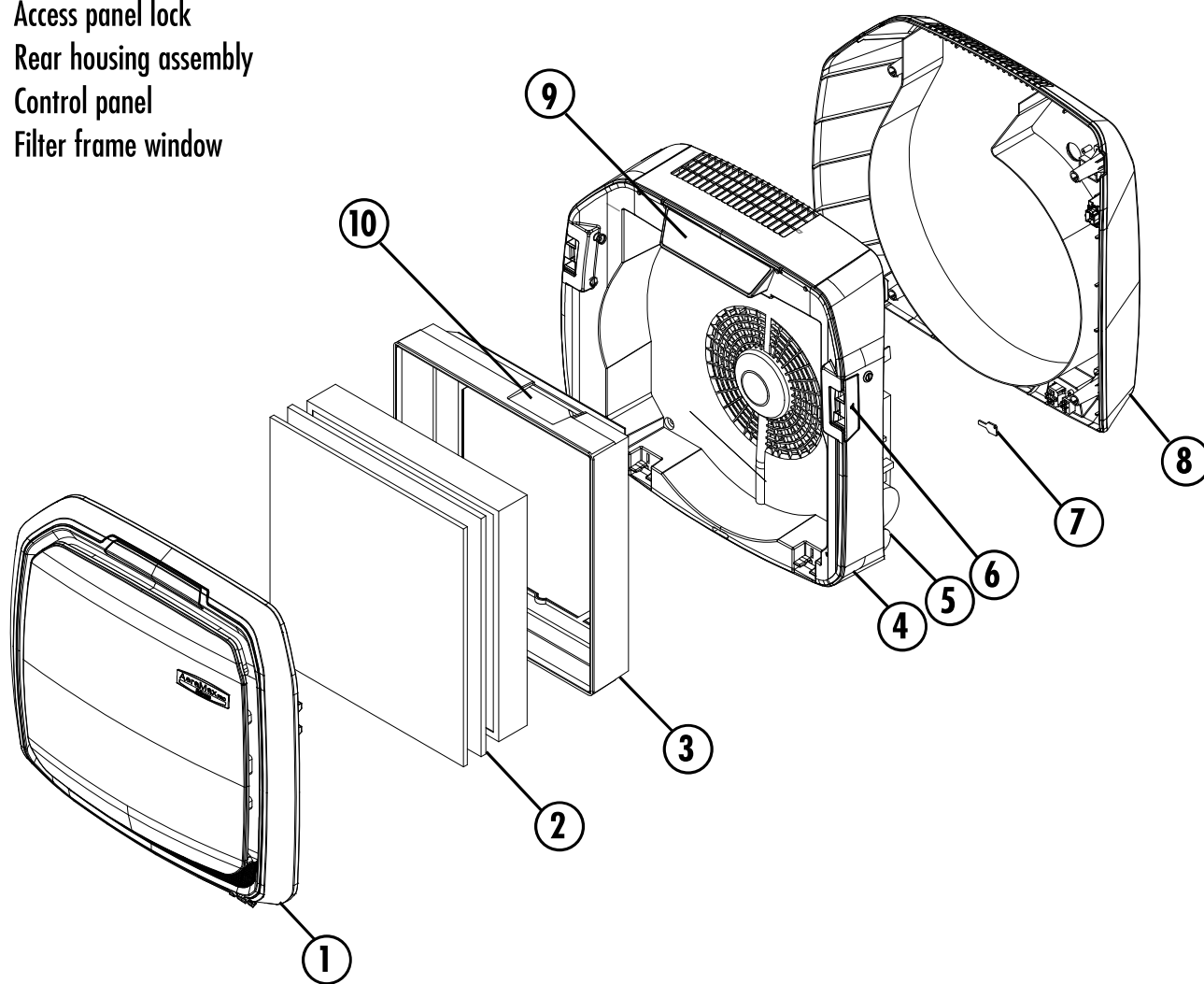

SAFETY

WARNING: To avoid the risk of electrocution confirm the electrical supply has been disconnected or switched off before beginning any installation work.

Confirm no electrical wiring, utility pipes, or duct work is located directly behind the installation / drilling area.

On a stud wall, it is strongly recommended at least 2 mounting anchors for the air purifier be mounted to an existing stud.

- The unit should be installed with a residual current protective devices (RCDs) with a rated residual operating current not exceeding 30 mA.
- When near a bath or a shower, the unit should be installed within the standard of Zone 2 or further.

TOOLS REQUIRED FOR INSTALLATION

- Electric drill, drill bits (not included)
- # 2 Phillips and # 2 Flat Head screw drivers (not included)
- Wire nuts (not included)
- Level (not included)
- Mounting template (included)

PARTS PROVIDED FOR INSTALLATION

- Drywall Anchors - 10mm OD
- Pan Head Phillips Screws

PRODUCT INSTALLATION GUIDELINES

Place the mounting template provided on the wall where the air purifier is to be installed. If air purifier is being mounted high on the wall make sure the top edge of the unit is positioned at least 8" inches (21 cm) below the ceiling to allow for filter replacement (see Fig 2).

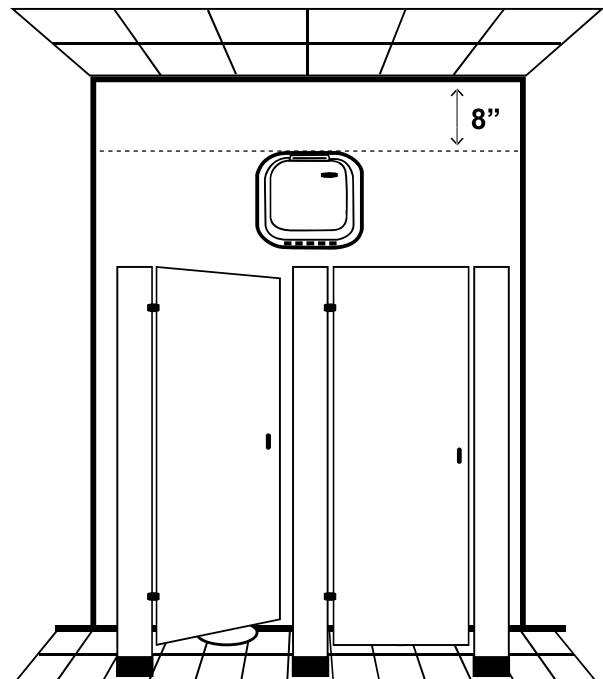
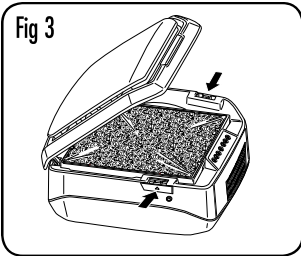

Fig 2

MOUNTING REAR HOUSING AND MAIN ASSEMBLY

Test the electrical outlet box first to ensure rated power requirements are met before beginning installation.

Remove air purifier from its shipping carton and remove all packing material.



Place the air purifier face up on a flat, stable work surface. Open the access panel by pressing in latches on each side of the unit (Fig 3).

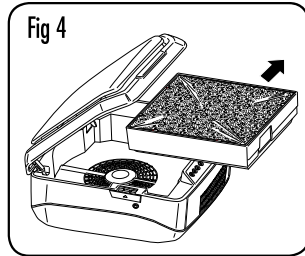

Open access panel and remove filter assembly by pulling out on top of side edges of frame, then lifting. NOTE: remove all plastic wrap from filters (Fig 4).

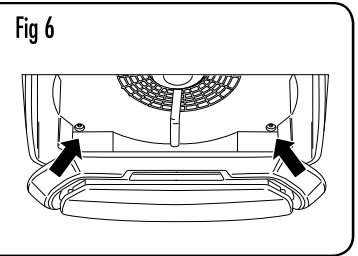
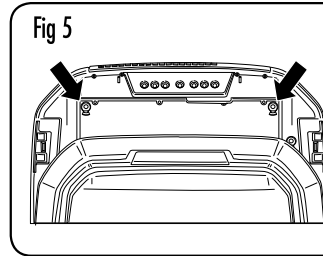

Remove the four housing screws (Fig 5 & 6) and set aside for re-assembly.

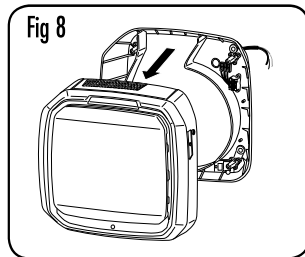
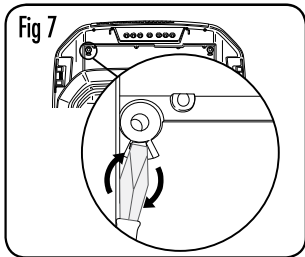

At the location of the two upper housing screws (Fig 5), insert a flat head screwdriver and gently twist to release tab as shown in Fig 7. This will disconnect main housing assembly from the rear housing assembly.

Disconnect main housing assembly from rear housing assembly. Separate main housing from rear housing. Lift main housing assembly away from rear mounting housing (Fig 8).

REAR HOUSING INSTALLATION & WIRING

Reference rear housing and locate desired mounting location. Again, it is strongly recommended at least 2 mounting anchors for the air purifier be mounted to an existing stud.

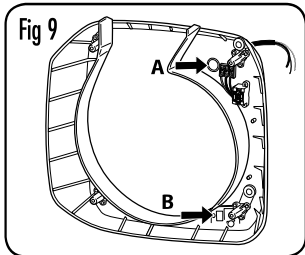

Using provided template ensure electrical outlet box is located behind cable hole (A) in Rear Housing assembly (Fig 9). Drill holes and place anchors in wall.

If mounting on concrete, cinder block or brick type walls route the wires through the "punch-out" hole marked (B) in Fig 9.

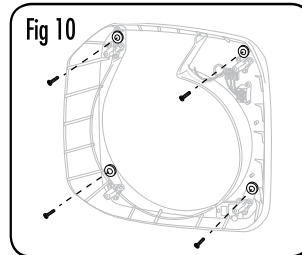

Check for washers at all mounting screw locations (Fig 10). Pull wires from electrical outlet box through hole in rear housing. Align housing over anchors and securely install all mounting screws.

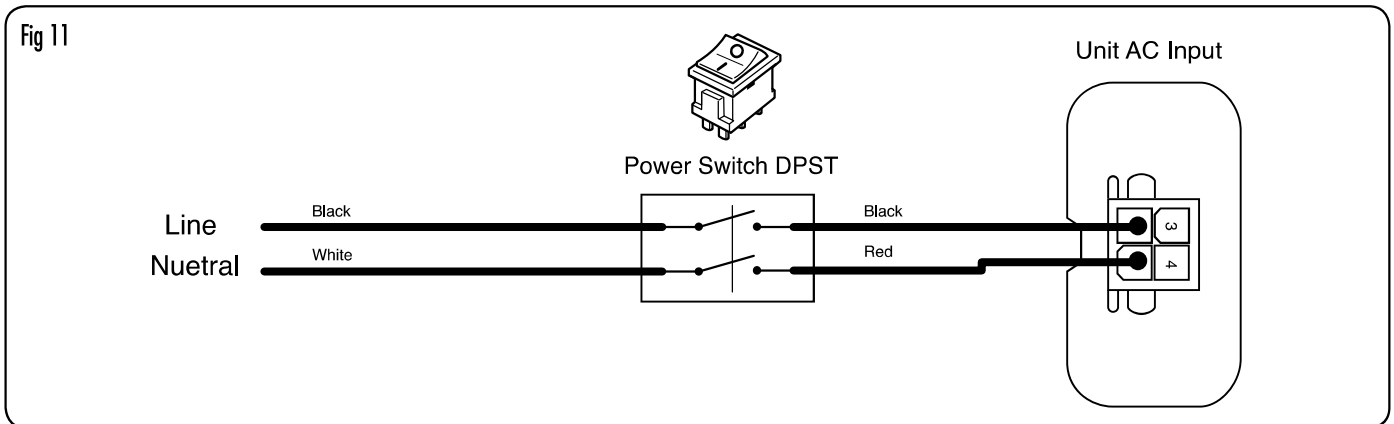

Attach wires from electrical outlet box to wires located inside rear housing using wire nuts. Match up line (black) and neutral (white) wires (Fig 11). Make sure all connections are made in accordance with federal, state and local codes and regulations.

MAIN ASSEMBLY INSTALLATION

WARNING: To avoid the risk of electrocution confirm the electrical supply has been disconnected or switched off before continuing any installation work.

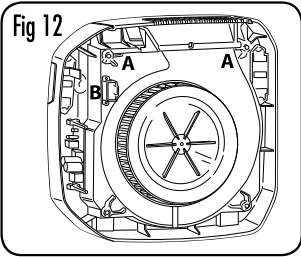

The power connector (B, in Fig 12) will carry power from the rear housing to the main housing once the assemblies are fully seated. The main assembly will attach to the rear housing assembly by the four screws previously removed (Fig 5 & 6). Two snap hooks (A, in Fig 12) will hold the main and rear assemblies together until the screws can be installed.

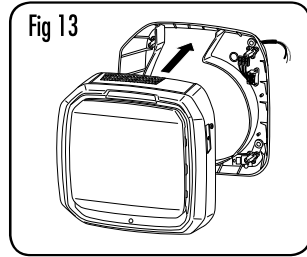

Carefully align the main assembly with the rear housing assembly. Slowly press into place until snap is heard, and there is no gap between the assemblies (Fig 13). The unit should now support its own weight.

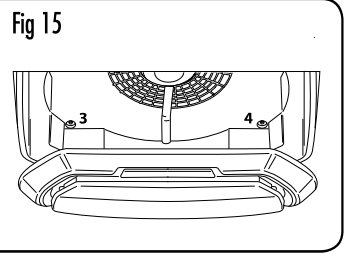
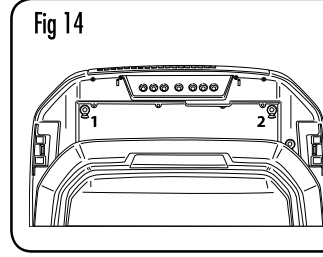

Install four screws (previously removed) to secure main assembly to rear housing assembly (Fig 14 & 15).

RE-INSTALLING FILTERS

IMPORTANT: Make sure all plastic wrap is removed from filters.

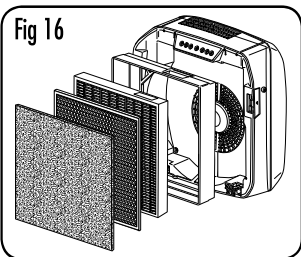

Make sure filters are in correct order - pre-filter / carbon filter / HEPA filter - and inserted into filter frame (Fig 16).

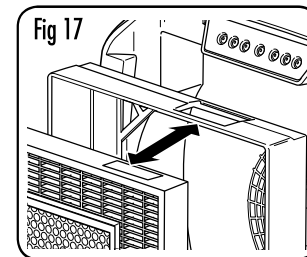

IMPORTANT: Make sure filter detection area aligns with window in filter frame (Fig 17).

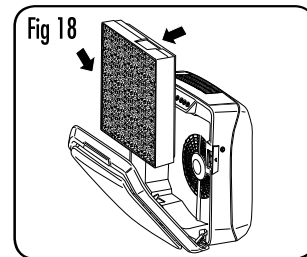

Open front panel by pressing latches on both sides of unit. Allow door to open fully. Insert filters - **IMPORTANT:** make sure filter detection window is aligned in upper right corner (Fig 18).

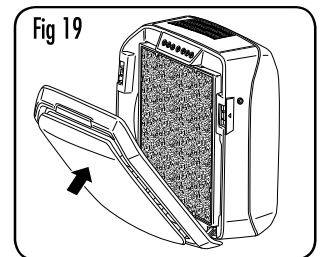

Close front panel by pressing firmly until both sides latch closed (Fig 19).

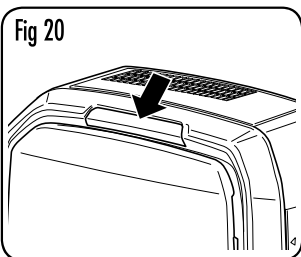

Once the unit is closed re-establish power. Lights on the control panel will be visible through the lens, indicating the unit is operational (Fig 20). The power light indicator will flash once a second.

LOCKING ACCESS PANEL

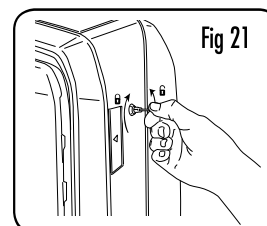

To restrict access to the control panel and filters the unit can be locked. To lock, insert the key provided and rotate clockwise $\frac{1}{4}$ turn (Fig 21).

CUSTOMER SERVICE & SUPPORT

www.fellowes.com

Europe Freephone: 00800-1810-1810
Benelux: +31-(0)-13-458-0580
Deutschland: +49 (0)511 545489-0
France: +33 (0) 1 78 64 91 00
Italia: +39-071-730041
Polska: +48 (22) 205-21-10
España/Portugal: +34-91-748-05-01
United Kingdom: +44 (0) 1302 836836

Declaration of Conformity

Fellowes Manufacturing Company

Unit 2 Ontario Drive, New Rossington, Doncaster, DN11 0BF, England

Declares that the product AeraMax® AMIII and AM3 PC Pro conforms to the following requirements:
[2011/65/EU-2015/863/EU] Restriction of Hazardous Substances Directive [2004/108/EC] Electromagnetic Compatibility Directive
[2012/19/EU] Electrical Product Waste Reduction Human Exposure to Electromagnetic Fields
[2006/95/EC] Low Voltage Directive

To the following harmonized European Names (EN Standards) and IEC Standards:
EN 55014-1 EN 60335-2-65 EN 61000-3-3
EN 55014-2 EN 61000-3-2 EN 62233
EN 60335-1

And to the following standards:
PPF 76001:2008 ind. APS GS 2014.01 PAK
AS/NZS CISPR 14.1:2003
German Equipment and Product Safety Act Section 7 Subsection 1 Sentence 2 GPFG

Itasca, Illinois, USA
June 1, 2019

John Fellowes
President & CEO

Fellowes
brand

1789 Norwood Avenue, Itasca, Illinois 60143 • 1-800-955-0959 • www.fellowes.com

© 2019 Fellowes, Inc. | Part #411641

AeraMax® Pro AM III and AM3 PC
AERA MAX
PROFESSIONAL

Air Purifier | Purificateur d'air | Purificador de aire | Luftreiniger
Purificatore d'aria | Luchtreiniger | Luftrenare | Luftrenser | Ilmanpuhdistin
Luftrenser | Oczyszczacz powietrza | Воздухоочиститель | Ιονιστής
Hava Filtresi | Čistička vzduchu | Čistič vzduchu | Légtisztító | Purificador de ar



Please read these instructions before use.
Do not discard: keep for future reference.

Lire ces instructions avant utilisation.
Ne pas jeter : conserver pour référence ultérieure.

Lea estas instrucciones antes de usarlo.
No las deseches: guárdelas para tenerlas como referencia.

Diese Anleitungen vor Gebrauch genau durchlesen.
Bitte nicht entsorgen: Zur späteren Bezugnahme aufheben.

Prima dell'uso, si raccomanda di leggere questo manuale di istruzioni.
Conservare il manuale per consultarlo secondo le necessità.

Deze instructies voor gebruik lezen.
Niet weggoaien, maar bewaren om later te kunnen raadplegen.

Les dessa anvisningar innan du använder apparaten.
Släng inte bort, behåll för framtida bruk.

Les venligst denne vejledning før anvendelse.
Bør ikke bortskaffes. Behold for fremtidig henvisning.

Lea nämia ohjeet ennen käyttöä.
Älä hävittä: säilytä myöhempää käyttöä varten.

Venligst les nøye gjennom denne bruksanvisningen før bruk.
Ikke kast den. Ta vare på den for senere referanse.

Przed użyciem proszę zapoznać się z tą instrukcją.
Nie wyrzucać – zachować jako źródło informacji na przyszłość.

Перед началом эксплуатации обязательно прочтите данную инструкцию.
Не выбрасывайте данную инструкцию: сохраните ее для последующего использования.

Παρακαλείσθε να διαβάσετε αυτές τις οδηγίες πριν χρησιμοποιήσετε το προϊόν.
Μην τις απορρίψετε: κρατήστε τις για μελλοντική αναφορά.

Kullanmadan önce lütfen bu talimatları okuyun.
Atmayın: ileride başvurmak üzere saklayın.

Před použitím si přečtěte tyto pokyny.
Nelikvidujte: uschovejte pro budoucí použití.

Pred použitím si prečítajte tieto pokyny.
Nezahadzujte: odložte pre budúce použitie.

Kérjük, hogy használat előtt olvassa el az utasításokat!
Az utasításokat ne dobja ki: tartsa meg referenciaként való jövőbeni használatra.

Leia estas instruções antes da utilização.
Não as deite fora: conserve-as para consulta futura.

ENGLISH

*For a copy of the manual please visit www.aeramaxpro.com

SAFETY INSTRUCTIONS/WARNING

Thank you for purchasing the AeroMax® PRO AM III.

Please read and save these instructions. Read carefully before attempting to assemble, install, operate or maintain this product. Protect yourself and others by observing all safety information. Failure to comply with instructions could result in personal injury and/or property damage. Retain instructions for future reference.

IMPORTANT CAUTIONS AND INSTRUCTIONS FOR USING AIR PURIFIER:

WARNING: Follow the instructions in this manual to reduce the risk of electric shock, short circuit, and/or fire:

- Do not use this air purifier as sole protection against harmful pollutants.
- Use this unit only in the manner intended by the manufacturer. If you have questions, contact the manufacturer.
- Installation work and electrical wiring must be done by qualified persons(s). All electrical installation work must be conducted and carried out in accordance with all federal, state and local codes and regulations.
- Before servicing or cleaning the unit, switch power off at service panel. Lock service panel, or affix a warning tag, to prevent power from being switched back on accidentally.
- Use only the electrical power (voltage and frequency) specified for the model air purifier being installed.
- Do not obstruct the air inlet or air outlet of the air purifier.
- When drilling into mounting surface, do not damage electrical wiring and other hidden utilities.
- Do not use unit without filters installed.
- Do not wash and reuse any of the filters.
- Do not use attachments or filters other than AeroMax® PRO brand, as unit will not function.
- Do not spray aerosols on, or into the unit.
- Do not use detergent to clean the unit.
- Do not insert fingers, liquids, or foreign objects into the air intake or outlet.
- Do not use the unit for anything other than air purification.
- If the supply cord is damaged, it must be replaced by the manufacturer, its service agent or similarly qualified persons in order to avoid a hazard.
- This appliance can be used by children aged from 8 years and above and persons with reduced physical, sensory or mental capabilities or lack of experience and knowledge if they have been given supervision or instruction concerning use of the appliance in a safe way and understand the hazards involved. Children shall not play with the appliance. Cleaning and user maintenance shall not be made by children without supervision.

LIMITED PRODUCT WARRANTY

Limited Warranty: Fellowes, Inc. ("Fellowes") warrants the AeroMax® PRO air quality control system (the "Product") to be free of defects in material and workmanship for the time periods as set forth below.

- For PC units only: The particle counters and display screen for a period of three (3) years from the date of original purchase of the Product.
- For standard and PC units: All other parts for a period of five (5) years from the date of original purchase of the Product. In the event that the Product is installed into new construction, the warranty period shall commence on the date of the occupancy permit or one year after the date of purchase, whichever is earlier. If any part is found to be defective during the warranty period, your sole and exclusive remedy will be repair or replacement, at Fellowes' option and expense, of the defective part. This warranty does not cover damage caused by use of non-Fellowes approved filters or failure to follow the recommended replacement schedule. This warranty does not apply in cases of abuse, mishandling, failure to comply with product usage standards, operation using an improper power supply (other than listed on the label), or unauthorized repair. Fellowes reserves the right to charge the consumers for any additional costs incurred by Fellowes to provide parts or services outside of the country where the Product was initially sold by an authorized reseller. This warranty does not cover replaceable filters. In the event that the Product is not readily accessible to Fellowes designated service personnel, Fellowes reserves the right to supply customer with replacement parts or Product in full satisfaction of its obligations under this warranty and any service obligations. ANY IMPLIED WARRANTY, INCLUDING THAT OF MERCHANTABILITY OR FITNESS FOR A PARTICULAR PURPOSE, IS HEREBY LIMITED IN DURATION TO THE APPROPRIATE WARRANTY PERIOD SET FORTH ABOVE. In no event shall Fellowes be liable for any consequential, incidental, indirect or special damages. This warranty gives you specific legal rights. The duration, terms, and conditions of this warranty are valid worldwide, except where different limitations, restrictions, or conditions may be required by local laws.

PACKAGING CONTENTS

- AeroMax® PRO Air Quality Control System
- True HEPA Filter with AeroSafe™ Antimicrobial Treatment (1 filter)
- Activated Carbon Filter w/Pre-Filter (1 of each filter)
- Keys for Locking Front Panel (2)
- Mounting Template
- Pan Head Phillips Screws - M6 x 50mm (4)
- Drywall Anchors - 10mm OD (4)
- Registration information

PRODUCT SPECIFICATIONS

AeroMax® PRO AM III	
Dimensions (H x W x D)	50.8 x 53.3 x 22.8 cm
Weight of System (including filters)	9.16 kg
Power Requirements	220-240V, 50/60Hz, 0.9A
Power Consumption (5 fan speeds)	5, 8, 11, 21, 109 watt
Air Delivery (5 fan speeds)	129, 158, 190, 238, 374 CFM
Decibels	38, 41, 48, 52, 67 dB
Display	Capacitive Touch, Internal Access Only
Sensors	EnviroSmart™
Sensor Controlled Operation Modes	2 Primary modes - Normal Mode and Quiet Mode
Supplied Filters	1 True HEPA Filter with AeroSafe™ Antimicrobial Treatment with an estimated average filter life of 1 year, 1 Activated Carbon Filter with Pre-Filter, estimated average filter life 6 months.
Cleaning System	High Efficiency Particulate Air (HEPA) filter rated efficiency of 99.97% of airborne particulate at 0.3 microns. Carbon filter adsorbs odor and volatile organic compounds, PlasmaTRUETM bipolar ionizer.

REPLACEMENT FILTERS

2" HEPA	True HEPA filter replacement with AeroSafe™ treatment. Average filter life 12 - 18 months: 9416602 - 2 pack
3/8" Carbon	Granular activated carbon replacement filter with pre-filter. Average filter life 6 months: 9416502 - 4 pack
2" Carbon	Granular activated carbon replacement filter. Average filter life 2 years: 9436802 - 2 pack
2" Hybrid 1"	True HEPA and 1" Carbon with pre-filter hybrid replacement filter. Average filter life 1 year: 9436902 - 2 pack

For additional replacement filter and accessory information please visit: www.aeramaxpro.com

INFORMATION TO THE USER

This equipment has been tested and found to comply with the limits for Class B digital device, pursuant to part 15 of the FCC Rules. These limits are designed to provide reasonable protection against harmful interference in an installation. This equipment generates, uses and can radiate radio frequency energy and, if not installed and used in accordance with the instructions, may cause harmful interference to radio communications. However, there is no guarantee that interference will not occur in a particular installation. If this equipment does cause harmful interference to radio or television reception, which can be determined by turning the equipment off and on, the user is encouraged to try to correct the interference by one or more of the following measures:

- Reorient or rebrake the receiving antenna
- Increase the separation between the equipment and receiver
- Connect the equipment on a circuit different from that to which the receiver is connected.
- Consult the dealer or experienced radio/TV technician for help.

WARNING: Any changes or modifications not expressly approved by the manufacturer could void the user's authority to operate the equipment and warranty.

DISPLAY PANEL

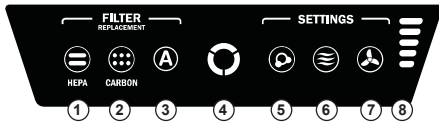

NOTE: after the unit is turned on the "AQ" light will flash for a few minutes while the system self-calibrates.

- 1 **HEPA FILTER REPLACEMENT INDICATOR** — This indicator will show its status when the access panel is open or closed. If the light is red this indicates the filter needs replacing. The replacement period will vary depending on the filters used, hours of use, air quality, and rate of air flow. For filter replacement indicator descriptions see **FILTER REPLACEMENT INDICATORS** section.
- 2 **CARBON FILTER REPLACEMENT INDICATOR** — This indicator will show its status when the access panel is open or closed. If the light is red this indicates the filter needs replacing. The replacement period will vary depending on the filters used, hours of use, air quality, and rate of air flow. For filter replacement indicator descriptions see **FILTER REPLACEMENT INDICATORS** section.
- 3 **ACCESSORY INDICATOR** — This indicator will show its status when the access panel is open or closed. This indicator will only be used if an accessory filter is installed in the unit. If the light is red this indicates the filter needs replacing. The replacement period will vary depending on the filters used, hours of use, air quality, and rate of air flow. For filter replacement indicator descriptions see **FILTER REPLACEMENT INDICATORS** section.
- 4 **AIR QUALITY SENSOR** — This indicator will show its status when the access panel is open or closed. This indicator monitors the air quality and adjusts the fan speed to keep your air purified. Blue, amber, and red lights indicate the purity of your air.
- 5 **PlasmaTRUE™ TECHNOLOGY** — This indicator will show its status when the access panel is open or closed. Creates an ionized field to help safely remove airborne pollutants. To turn on and off the PlasmaTRUE™ TECHNOLOGY, touch and hold the PLASMA indicator. A blue light illuminates when the PlasmaTRUE™ TECHNOLOGY is enabled. To disable the PlasmaTRUE™ TECHNOLOGY, press and hold "Plasma" indicator until light is off.
- 6 **AUTO MODE** — To select, press and hold the button until the icon illuminates. This mode uses the EnviroSmart™ technology to monitor the air quality, motion and noise level to adjust the fan speed in order to purify your air as quickly as possible. This button also includes QUIET MODE. To select, press and hold until the button turns purple. The machine will continue to use EnviroSmart™ but only utilizes the 3 lowest, most quiet of the 5 fan speeds.
- 7 **MANUAL MODE** — To select, press the button until the icon illuminates. This mode allows you to choose one of the 5 fan speeds and keep the unit at this speed until AUTO MODE is chosen again. The internal sensors will not adjust the fan speed in this mode.
- 8 **FAN SPEED INDICATORS** — The fan has 5 speeds and can reach turbo speed to clean the room in case of high levels of contaminants. The number of bars illuminated indicates fan speed.

1 — whisper	4 — high
2 — low	5 — turbo
3 — medium	

OPERATION

The air purifier continuously works in automatic mode; the user can select which preference they would like the purifier to use based on the location or desired operation of the air purifier. The purifier will operate through a minimized range of speeds, not exceeding the maximum level selected, in order to run quietly while cleaning the room of contaminants. Once air is cleaned, and no sensors are activated, the unit lowers to energy saving mode to reduce energy consumption and extend the life of the filters.

When Auto Mode is selected, the Auto mode indicator will be blue. This mode uses the EnviroSmart™ technology to monitor the air quality, motion and noise level to adjust the fan speed in order to purify your air as quickly as possible. Once air is cleaned, and no sensors are activated, the unit lowers to energy saving mode to reduce energy consumption and extend the life of the filters.

The machine will continue to use EnviroSmart™ but only utilizes the 3 lowest, most quiet of the 5 fan speeds.

When Manual Mode is selected, the Manual mode indicator will be blue. This mode allows you to choose one of the 5 fan speeds and keep unit at this speed until Auto Mode is chosen/selected. EnviroSmart™ sensors will NOT adjust the fan speed in this mode.

CARE AND MAINTENANCE

CLEANING:

- Clean external housing as necessary by wiping with a dry, soft cloth; for stains, use a warm, damp cloth.
- Do not use volatile fluids such as benzene, paint thinner, scouring powder or other cleaners that may damage the unit surface.
- Clean intake and exhaust vents by wiping with a dry, soft cloth.

FILTER REPLACEMENT INDICATORS:

The replacement filter indicators will signal when to replace the HEPA Filter and/or Carbon with Pre-Filter. The replacement period will vary depending on the hours of use, air quality, and rate of air flow. However, under normal usage, most HEPA Filters need to be replaced every 2 years, and Carbon with Pre-Filter every 6 months. When a filter needs to be replaced the following color will be shown on any one of the HEPA, CARBON, or ACCESSORY filter replacement indicators:

- Red flashing = 90% filter wear (recommendation to order new filters)
- Red steady = 100% filter wear (replace with new filters)

Do not wash and reuse any of the filters — they will not work effectively. Only use AeraMax® PRO brand replacement filters as units will not function using any other replacements.

FILTER REPLACEMENT PROCEDURE:

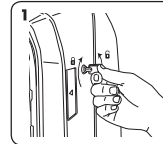

Unlock access panel: to unlock, insert the key provided and rotate counter-clockwise 1/4 turn.

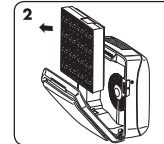

Open front access panel by pressing latches on both sides of unit. Allow panel to open fully. Remove filter(s) to be replaced.

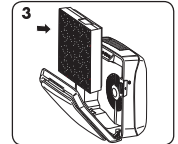

Remove any packaging wrap from the new filter(s) and re-install the filters.

FILTER REPLACEMENT:

When installing a new filter the unit will automatically detect the filter type but the user will have to manually reset the filter replacement indicators. To reset any of the filter replacement indicators use the following procedure:

- 1 Touch and hold the illuminated indicator for three seconds until a beep is heard and the indicator is flashing green.
- 2 Release finger from indicator.
- 3 Touch and hold the indicator for three seconds until a beep is heard and the indicator light turns off.

NOTE: If you do not complete step three within 10 seconds of completing step 1 then the indicator light will not be reset.

TROUBLESHOOTING

PROBLEM:	POSSIBLE SOLUTION:
The air quality control system fails to start.	<ul style="list-style-type: none"> • Check to assure unit is connected to power supply. • Make sure filters are genuine AeraMax® PRO filters, as unit will not function with other brands. IMPORTANT: Make sure filter detection area on genuine AeraMax® PRO replacement filter aligns with window in filter frame. • Review "Re-Installing Filters" section for further detail. • Make sure front access panel is closed completely. • Make sure power switch is on.
The unit makes a faint ticking sound.	<ul style="list-style-type: none"> • This indicates that the "PlasmaTRUE™" bipolar ionizer is working.
The HEPA and/or Carbon Filter replacement indicator light remain lit after replacing the filter(s).	<ul style="list-style-type: none"> • Repeat filter light reset instruction.